



Crendon Nominees Pty Ltd A/T/F
the Fry Family Trust T/A: Crendon Machinery
ACN 009 135 335 ABN 53 913 250 628

2 Ramsay Tce
PO Box 95
DONNYBROOK WA 6239

Ph: (08) 9731 1502
Toll Free: 1300 761 922
Fax: (08) 9731 1657
Email: info@crendon.com.au
www.crendon.com.au

Manufacturers and Designers of Horticultural and Viticultural Equipment
* **SQUIRREL** self propelled elevating platforms * **SADIE** vineyard & orchard sweepers * **NETWIZZ** netting retriever

SQUIRREL Parts Catalogue #4 **Hydraulic Filters, Valves, Pumps,** **Motors.**

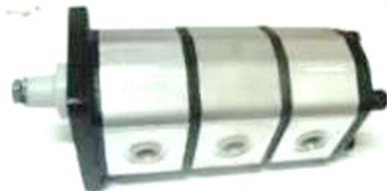

<i>SQUIRREL Parts Catalogue # 4</i>	<i>Page</i>
<i>Hydraulic Filters Suction, Vacuum gauge</i>	12
<i>Hydraulic Filters Return, Tank Sighter, Return filter gauge ...</i>	14
<i>Hydraulic Ball Valves, Check Valves.....</i>	14
<i>Hydraulic Dump Valves, Change over Valves</i>	15
<i>Relief Valves, Tool Valves, 6 Port Diverter</i>	16
<i>Hydraulic 3 Speed Solenoid Valves</i>	16
<i>Hydraulic Spool Valves - (Akon ATM50).....</i>	18
<i>Hydraulic Spool Valves - (Galtech Q45).....</i>	19
<i>Hydraulic Spool Valves (Moore)</i>	20
<i>Hydraulic Spool Valves - (Salami)</i>	21
<i>Hydraulic Stackable Solenoid Valves</i>	21
<i>Hydraulic Spool Valves (QT).....</i>	22
<i>Hydraulic Pumps</i>	23
<i>Hydraulic Motors –BMSY, BMER-2.</i>	24
<i>Hydraulic Motors –BMRS</i>	25
<i>Hydraulic Motors – (Char-Lynn) (White)</i>	26
<i>Hydraulic Motors – (Danfoss) (Renold) (Senwei) (M&S)</i>	27
<i>Hydraulic Testing Kit & Pressure Gauges.....</i>	37

Hydraulic Suction Filters (very big)



Suction Filter hydraulic element only SPX-20mic, 140mm diameter, 330mm long, paper filter- **FHSP140x330-20P** \$83.64 + GST (From 2021 *This is what we are using now*)



Bulk buy 5 x Suction Filter hydraulic element SPX-20mic, 140mm diameter, 330mm long – **FHSP140x330-x5** total \$ 362.45 = \$ 72.49 each + GST (From 2021 *This is what we are using now*)



Suction hydraulic Filter head only, 1 1/4" BSP ports to take above elements, 3-4 psi bypass, 140mm diameter, 330mm long, – **FHSP11/4H** \$59.34 + GST (From 2021 *This is what we are using now*)



Filter hydraulic complete SP10X10 10mic suction 1 1/4" BSPT - 125mm diameter, 170mm long **FHSP1010J**

Filter hydraulic complete SP10X10 10mic suction 1 1/4" BSPT - 125mm diameter, 270mm long **FHSPBX10HE270*** \$104.48 + GST

Filter hydraulic complete SP10X10 25mic suction 1 1/4" BSPT - 125mm diameter, 270mm long **FHSPBX25HE270***

Hydraulic Suction Filters elements



Filter hydraulic element only SPX-10X10 10mic, 125mm diameter, 170mm long - **FHSP10X10E**

Filter hydraulic element only SPX-10X10 10mic, 125mm diameter, 270mm long, fine thread (for all 005 & 006 models) - **FHSPBX10E**

Filter hydraulic element only SPX-10X25 25mic, 125mm diameter, 270mm long, fine thread (for 008 2020 models) – **FHSPBX25E008**

Filter hydraulic element only SPX-10X10 10mic, 125mm diameter, 270mm long, coarse thread (for all 008 2019 models) - **FHSPBX10E008**

Hydraulic Suction Filters



Suction Filter stainless steel glycerine filled vacuum gauge Ø40mm 1/8" BSPT – **FHSFVGSSG**



Filter hyd Element only, 10-micron, PRINCE FB10, 1 1/2-16 UN-2A internal thread, 125mm diameter 170mm long – upgraded to 140mm diameter 190mm long **FHFB10** \$64.80 + GST

Filter head & element PRINCE 1 1/4" BSPT (large 125mm diameter x 170mm long) - **FHFB1100-10**



Suction Filter 3/4" BSPT (1970 - 1985) **SSF64A-34GO**



Ball valve 1 1/4" BSP stainless steel for suction filter (from 2023) **VB114FSS**

Hydraulic Return Filters



Return Filter element, 5-micron SPX-06x10 Ø96mm x 210mm high, paper filter, – **FHSP96x210-5P** \$33.66 + GST (From 2021 *This is what we are using now*)



Bulk buy Return Filter element, 5-micron SPX-06x10 Ø96mm x 210mm high – **FHSP96x210-x5**
Total \$ 145.85 = \$ 26.17 each + GST (From 2021 *This is what we are using now*)



Return hydraulic Filter head only, 3/4" BSP ports 25 psi bypass, to take above elements, 96mm diameter, 210mm long, – **FHSP3/4H** \$41.58 + GST (From 2021 *This is what we are using now*)



Return Filter element, 10-micron Dffiltri SPX-06x10 Ø93mm x 130mm high (small) – **FHSP06x10E**



Return Filter head & element Dffiltri SP-06x10 Ø93mm x 130mm high 3/4" BSPT (small) – **FHSP06x10**



Return Filter head & element PRINCE 3/4" BSPT Ø93mm x 130mm high (small) - **FHFA1200-10**

Hydraulic Return Filters



Return Filter element, 10 micron, FA10 for above Ø93mm x 130mm high PRINCE 3/4" BSPT (small) – **F.....**



Return Filter hydraulic element RYCO R14 (pipe frame replaces Moore filter) - **RPR14**



Return Filter stainless steel glycerine filled pressure gauge Ø40mm 1/8" BSPT – **FHRFPGSSG**

Oil Tank Sighter



Oil tank sighter 250mm with aluminum cover – **OLIYWZ250CC250** (all 006 models)



Oil tank sighter 150mm with aluminum cover – **OLIYWZ150CC150** (all --8 models)



Oil tank breather 3/4" BSP - **FBF1034**

Hydraulic Small Valves



Needle/check Valve 3/8" BSPT (*boom descent speed valve*) – **VNC38** \$23.05 + GST



Needle Valve adjustment in-line 3/8" BSPT FT1251 – **VNAIL3/8**



Ball valve 3/8" BSPT (hydraulic) 2 way – **VBVH3/8**



Ball valve Stainless Steel 3/8" BSPT (hydraulic) 2 way (*boom emergency descent valve*) – **VN3BSPTFS**

Hydraulic Small Valves



Check valve 3/8" BSPT in-line FT260638 – **VCIL3/8FT260638**



Check valve 3/8 BSPT throttle barrel style – **VC3/8TB**

Double Pilot Check Valve



Double pilot operated check valve 3/8" BSPT ports 4:1 pilot ratio; **VCDPO3/82OL**

Double pilot operated check valve 1/4" BSPT ports 4:1 pilot ratio; **VCDP014**



Double pilot operated check valve 9/16 UNO ports – Hydraulic tube to mount on rams, pilot ratio 8:1 **VDPCV8:1 9/16**

Hydraulic Change Over Valves



Change over valve 3 port 3/8" BSPT (*old Two Speed*) – **VC03P3/8**



Seals for above 2 speed valve 1 x – **ORBS114-90**
1 x – **ORBS116-90**

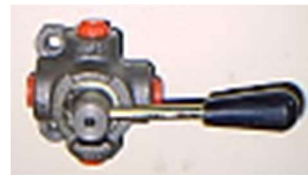

Change over valve 4 Way 3/8" BSPT D4V38CC (*655 & 805 hydraulic wheel shift valve*) – **VD4WAY3/8** \$70.20 + GST



Three Speed control (*for old 3 speed*) – **VD4WAY3/83SPD***



Seals for both above 4 Way valve 2 x **ORBS120-90**

Solenoid Dump Valves



Solenoid dump valve 1/2" BSP ports, 12V DC, 3 pin terminal led plug, used 3 speed valve on old Squirrels from C Hyd- **VSD123PLED***



Solenoid dump valve 3/8" BSP ports, 12V DC, IP67, 0-6 lpm, deutsch plug (SV08-28-G12ZJ-12V DC) (used for emergency descent from 2021)- **VSDSV0828G12ZJ**



Solenoid dump valve 3/8" BSP ports, 12V DC, IP67, 0-6 lpm, deutsch plug (SV10-28-G12ZJ-12V DC) used 3 speed valve on old Squirrels - **VSDSV1028G12ZJ**

Hydraulic Tool Valve



Hydraulic Tool Valve Block outlets, 3/8" BSPT ports (Diverter & Relief Valve) - **VHOTR**

Hydraulic Relief Valves



Relief valve Inline 3/8" VSC30 10 spring - **VR3/8IL**
 Relief valve Inline 3/8" VSC30 20 spring - **VR38IL20**
 Relief valve Inline 1/2" VSC30 10 spring - **VR1/2IL**
 Relief valve Inline 1/2" VSC30 20 spring - **VR1/2-20IL**



Double cross line Relief valve & Shuttle valve, for brake release & motor pressure, 3/4" UNO & 9/19" UNO (2010 - 2019) - **VDCLRS34**



Double Relief valve drain to tank & Shuttle valve, for brake release & motor pressure, 3/4" UNO, 1/4" BSP, 9/19" UNO (358, 558, 678 & 818) - **VDCLRS34DTT**



O-ring for Double Relief valve adjustment thread, some use 2 O rings (10x2N90), fits the above valve body (2010 - 2019) - **ORM10X2N90**



Shuttle valve, for brake release, fits the above valve body (2010 - 2019) - **VDC.....**



Double Relief valve drain to tank for motor pressure, ports 3/4" UNO & 1/4" BSPT - **VDCLRP34**

Hydraulic 6 port diverter Valves



Elect selector valve 6 port 1/4" BSPT solenoid operated (bin forks valve) - **VS6PE14CH** \$148.86 + GST



Coil and boot 12VDC 4 prongs, for 6 port 1/4" select valve for above - **VCS6PE14CCH** \$31.00 + GST



Elect selector valve 6 port, 9/16 UNO ports, Deutsch solenoid IP67 (bin forks valve 358, 558, 678 & 818 Squirrels) - **VS6PE14SJ** \$132.73 + GST



Elect selector valve 6 port, 9/16 UNO ports, Deutsch solenoid IP67, manual override (bin forks valve 358, 558, 678 & 818 Squirrels) - **VS6PE916DNO** \$..... + GST

Hydraulic New 3 speed Solenoid Valves



Three speed valve bank; Manifold block, 3/4" UNO, 12DC & 2 x Cartridge dump valves, 2 x check valves, Deutsch P67 coils (All Squirrels from 2022) - **VE3SCVCVDP*** \$462.20 + GST



Three speed cartridge valve DHF 10-223, normally open, for top port (All Squirrels from 2022) - **VE3SCV10-223** \$79.16 + GST



Three speed cartridge valve DHF 10-222 normally closed, for bottom port (All Squirrels from 2022) - **VE3SCV10-222** \$88.30 + GST



Three speed check valve DF 10-05/0.N.05 (All Squirrels from 2022) - **VE3SCV10-05**



Three speed cartridge valve Coil; Deutsch plug, inside diameter 16mm, fits 222 & 223 cartridge valves (All Squirrels from 2022) - **VE3SC1612VDP** \$53.52 + GST

Hydraulic Old 3 speed Solenoid Valves



Manifold block, 3/4" UNO, 12DC & 2 x C-top 3 valves (Electric 3 speed valve) (all from mid-2015 - 2019) – **VE3SPDBR** \$339.73 + GST



Electric valve single acting (C-top 3) (for 3 speed valve) block– **VESCT3SACH** \$165.64 + GST



Coil and boot 12VDC 3 prongs, for 3 speed valve for above – **VCS3SE3CH** \$35.00 + GST

Hydraulic 3 speed Relief Valves



C top 3 relief valve (P port to T port) for 3 speed front pump, sandwich between the bottom valve bank and solenoid valve fits to any electric 3 speed Squirrel – **VESCT3SRV** \$89.09 + GST

Hydraulic Old 3 speed Solenoid Valves



Manifold block, 3/4" UNO, 12DC & 2 x C-top 3, Deutsch, IP67 valves (Electric 3 speed valve) (358, 558, 678 & 818) – **VE3SPDBRD67** \$396.80 + GST



Electric valve single acting (C-top 3) Deutsch plug, Rubber boot, IP66, for 3 speed valve for above – **VESCT3SACHDP** (358, 558, 678 & 818) \$161.60 + GST



Electric valve single acting (C-top 3) Deutsch plug with manual lock override, IP65, for 3 speed valve for above – **VESCT3SAMLDP** (358, 558, 678 & 818) + GST



Coil 12VDC Deutsch, IP67, for 3 speed valve for above – **VCS3SE3CHDP** (358, 558, 678 & 818) \$54.55 + GST



Coil plunger actuator for 3 speed valve, IP67, for rubber plug end above – **VCPA3CH67** (358, 558, 678 & 818) \$21.00 + GST



Coil plunger actuator poll for manual lock cap all 3 speed valve, IP65 – **VCPA3CH** \$21.00 + GST



Manual lock cap for all 3 speed valve (fits on the not-water proof actuator pole) – **VCMLC3** \$28.68 + GST

Hydraulic Spool Valves (Akon ATM50)
Series Circuit after 5-2018



Series Circuit, two spools, Double acting Spools, 3/4" UNO ports, grade 70 O-rings, for boom lift single acting spool, *(no alteration done)* **VCAMV502LRSSC1S**

Hydraulic Spool Valves (Akon ATM50)
Parallel Circuit



Parallel Circuit, Double acting Spools, 1/2" BSP ports, grade 70 O-rings, for lift and side swing only, for up grading on pre 2013 models, load check valve on both ports, *(no alteration done)* **VCAMV502BSC1ST1**



Motor Drive Controls, Series Circuit, two spools, Double acting Spools, ports 3/4" UNO ports, grade 90 O-rings, ground spools, extra SHCS, for drive light springs, *(for Drive controls from 6-2018)* **VHCA2S-SQ***

Boom & Side Swing Controls, Series Circuit, two spools, Spools, 3/4" UNO ports, grade 90 O-rings, for boom lift single acting spool, *(for Lift & Side Swing controls from 6-2018)* **VHCA2SL&SS-SQ***

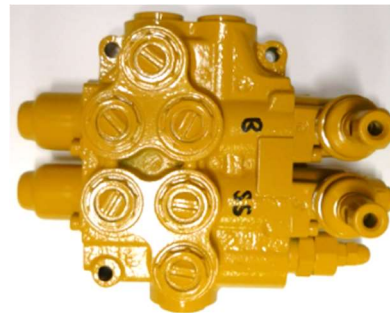

Parallel Circuit, Double acting Spools, 1/2" BSP ports, grade 90 O-rings, lift spool ground, spring changed on side swing spool, for lift and side swing only, for up grading on pre 2013 models, load check valve on both ports, *(all alteration done)* **VHCA2SL&S-SQPS***

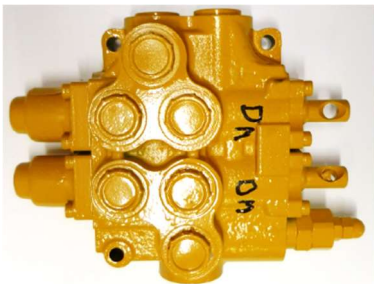

Motor Drive Controls, Series Circuit, two spools, Double acting Spools, ports 3/4" UNO ports, grade 90 O-rings, polished spools, light springs, spool dust covers, *(for old chain drive Squirrels)* **VHCA2SDC-SQ***

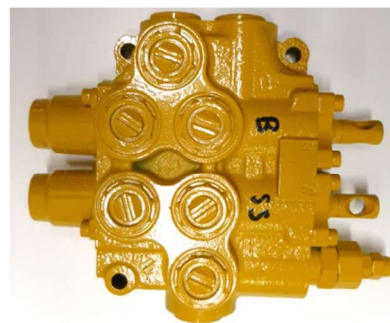

Parallel Circuit, Double acting Spools, 1/2" BSP ports, grade 90 O-rings, lift spool ground, spring changed on side swing spool, for lift and side swing only, load check valve on both ports, spool dust covers, *(for old chain drive Squirrels with side swing)* **VHCA2SL&S-SQPSDC***

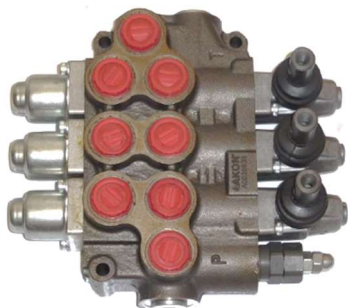

Series Circuit, three spools, Double acting Spools, 3/4" UNO ports, grade 70 O-rings, for boom lift single acting spool, *(no alteration done)* **VCAMV503LRSSC1S**



Parallel Circuit, Double acting Spool, 1/2" BSP ports, grade 90 O-rings, lift spool ground, for lift only, load check valve, spool dust cover, *(for old chain drive Squirrels no side swing)* **VHCA1SL&SQPSDC***

Hydraulic Spool Valves Parts (Akon AVM50) after 5-2018



Spring Compression 1"ODx14gx40mm (light) drive – **SBC1OD14G40**

Spring Compression 1"ODx12gx40mm (medeam) side swing – **SBC1OD12G40**

Spring Compression 1"ODx10gx40mm (heavy) lift – **SBC1ODX10GX40**

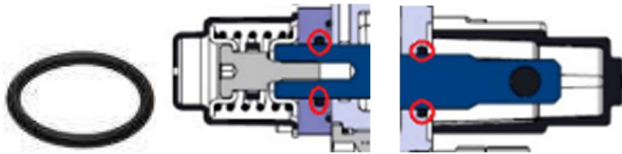

O-Ring grade 90 0.612" ID x 0.103" BS114-90 2 required per spool, for all Akon Valves (2019 and newer) in the red circle pictured above – **ORBS114-90**

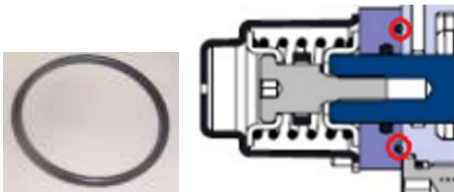

O Ring grade 90 1.051" ID x 0.070", for Motor Drive Controls, Series Spools, 1 required per rear cap Spacer (2018 only) in the red circle pictured above - **ORBS023-90**



Akon handle boot washer seal retainer, for all Akon Valves- **VCAM50BW**



Akon front spool cover plate, required if not using handle boot assy, for all Akon Valves – **VCAM50DPK**



Akon handle boot, for all Akon Valves- **VCAM50BA**

Hydraulic Spool Valves Parts (Akon AVM50) after 5-2018



Akon rear Cap & spring assy all Akon Valves – **VCAM50RBC&S**



Socket head cap screw for handle and rear boot ends M5x20, for all Akon Valves – **BSHCM5x20ZP**



Akon Spool, Series Circuit, ground to suit Boom lift Controls – **VCAM50SDASBL***



Akon Spool, Series Circuit, ground to suit Motor Soft Drive Controls – **VCAM50SDASMSD***



Akon Spool, Series Circuit, Standard Spool for Side Swing Controls – **VCAM50SDAS**

Hydraulic Spool Valves Parts (Akon AVM50) before 5-2018



Akon rear Cap spacer for Series Circuit Akon Valves (2018 only) – **VCAM50ARBS**



O Ring grade 70, 16 ID x 1.5mm, for Motor Drive Controls, Series Spools, 2 required per body before rear cap Spacer (2018 only) – **ORM16x1.5**

Hydraulic Spool Valves - (Galteck Q45)

(Has- 7,000 psi seals, good smooth feathering & custom ground spools) (1995 - 6-2018)



Std Valve Galteck Q45 single spool, cylinder double acting spool – **VHCG1S**

Crendon/ Galteck Q45 single spool, cylinder double acting spool, 7,000 psi seals, taped, re-pinned, painted – **VHCG1S-SQ**



Std Valve Galteck Q45 double spool, cylinder double acting spool – **VHCG2S**

Crendon/ Galteck Q45 double spool, cylinder double acting spool, (Has- 7,000 psi seals, good smooth feathering & custom ground spools) (1995 - 6-2018) **VHCG2S -SQ**



Side swing valve Spool standard (double acting cylinder; Galteck Q45) – **VHCGSC**



Drive valve Spool, Soft drive (double acting cylinder ground down for soft drive); Galteck Q45) – **XSSDG***



Lift valve Spool, (double acting cylinder ground down for lift ram); Galteck Q45) – **XSLRG***



Galteck Q45 Spring Compression 200Dx15gx35mm (light) drive – **SBC200DX15GX35**

Galteck Q45 Spring Compression 200Dx2mmx35mm (medium) Side Swing – **VHCGQ45SM**

Galteck Q45 Spring Compression 200Dx2.15mmx35mm (Heavy) lift – **VHCGQ45S**

Hydraulic Spool Valves - (Galteck Q45)



Handle bracket assay Galteck Q35/45 no Handle – **VHCGHBA**



Handle assay for Galteck Q45 Valve – **VHCGHA**



Socket head cap screw for rear boot ends M5x20, for Galteck Q45 Valve – **BSHCM5x20ZP**



Cable Cap connect kit for Galteck Q45 Valve – **VHCGCCKQ45**



Cap (rear) for Galteck Q45 Valve – **VHCGRC**



Rear Spring assay for Galteck Q45 Valve – **VHCGSKM1.**



O-ring 113-90 grade 90 & O-ring back up for Galteck valve must be used with black encapsulated Seal retainer-

O-ring – **ORBS113-90**

Back up – **ORBUW113**



Encapsulated Seal 14x18.51x4.2mm White – **ORES186*139*20-A**

(Use 1 off each end of spool) (need to use encapsulated Seal retainer)



O-ring encapsulated Seal retainer 14.15x8.1mm – **VHCGSR1415**

(Use 1 off per seals O-ring encapsulated Seal)
Hydraulic Spool Valves (Moore)



Hyd Valve Malcolm Moore **Not available** (1965 - 1975)

Hydraulic Spool Valves Spares (Moore)

Parts



Spring Compression 1"ODx14gx40mm (light) drive - **SBC1OD14G40**

Spring Compression 1"ODx10gx40mm (heavy) lift - **SBC1ODX10GX40**

O-Ring 0.549" ID x 0.103" BS113 - **ORBS113**

O-Ring 0.737IDx0.103" BS116 - **ORBS116**

Quad ring - **QR113**

Quad ring - **QR116**



Spool washer MOORE Valve - **VHMW**

Circlip Moore valve Spool - **CEXT056**



Spool cap MOORE valve - **VHMSC**

Not available

Hydraulic Spool Valves - (Salami)



Single valve 1 cyl spool 2act no HPCO Salami VDM07- (1975 - 1995) **VSDM071S2AWH27**



Double valve 2 cyl spool 2act no HPCO Salami VDM07 - (1975 - 1995) **VSVDM072S2AH**

Hydraulic Spool Valves Spares - (Salami)



Motor spool VDM07 - **VSVDM071220**

Cylinder spool VDM07 Double acting - **VSVDM071120**



O-ring for spool 0.612" ID x 0.103" BS114 - **ORBS114**



Detent kit SALAMI VDM07 - **VSEDEKIT**



Boot for SALAMI VDM07 - **VSBOOT**



Lever/knob SALAMI VDM07 - **VSHANDONLY**



Handle kit (BOOT&LEVER) SALAMI VDM07 - **VSHANDKIT**



Control Spring SALAMI VDM07 - **VSVDM07SPRING**



Cap, plate, steel washers, studs, spring SALAMI VDM07 - **VSCPNSW**



High pressure carryover VDM07 - **VSVDM07HPCO**

Hydraulic Stackable Solenoid Valves for 657 & 807 Squirrels



Electric bin forks & crab drive 12DC C top 4 valve (DS4WE stackable C top 4) – (**7) – VESS



Inlet manifold – DS4WE stackable DS4WE stackable C top – VCIMD54WE

Hydraulic Spool Valves QT for 657 & 807 Squirrels



Single monoblock double acting ram spool, 20 l/pm – (Side swing **7) - VHCDCV20-1CH



Triple monoblock double acting ram spools, parallel, 20 l/pm – (ground controls **7) - VHCDCV20-3CH



Triple monoblock double acting ram spools, series circuit, remote hydraulic pilot proportional, 80 l/pm – (ground drive controls **7) - VHPP3S40L



Triple remote hydraulic pilot proportional, 4 l/pm – (Cage foot controls **7) - VHPP3HC



Pivot Bracket for remote hydraulic pilot proportional control - (Cage foot controls **7) - VHPPPB



Joystick hydraulic pilot proportional, 4 l/pm – (Cage hand controls **7) - VHPPJHRCV0000

Hydraulic Pumps – (GRH, 4,400 psi seals, very high-quality pump) (from 9-2023)



Hydraulic Pump Triple GRH 8+6+6cc Group2 4bolt flange 1/2" BSP & 3/4" UNO ports, Cast iron end (all Squirrels from 2021 except for 818) – PHTS 8/6/6 \$723.21+ GST



Hydraulic Pump Triple GRH 8+6+4cc Group2 4bolt flange 1/2" BSP & 3/4" UNO ports, Cast iron end (Squirrels 818B from 2021) – PHTS 8/6/4 \$723.21+ GST

Hydraulic Pump Spares – (GRH)



Seal kit Group2 GRH triple pump (from 9-2023) – PHTGRHG2SK \$54.11 + GST

Hydraulic Pumps – (Koreson, 4,400 psi seals) (from 6-2018)

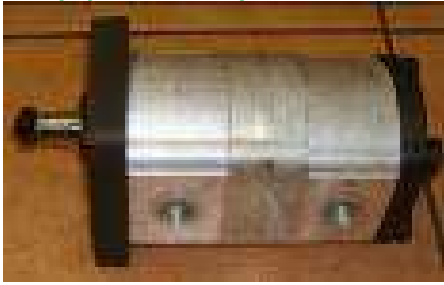

Hydraulic Pump Double *Alfred* 4+4cc 4bolt flange, 1/2" BSP suction side & 3/4" UNO ports pressure side, Cast iron end (older 2 speed Squirrels) – **PHG2D4/4CICH**

Hydraulic Pump Double *Alfred* 6+4cc 4bolt flange, 1/2" BSP suction side & 3/4" UNO ports pressure side, BSP Cast iron end (3 speed Squirrels) – **PHG2D 6/4CICH**



Hydraulic Pump Triple *Koreson* 6+6+4cc, Group2, 4bolt flange, 1/2" BSP suction side & 3/4" UNO ports pressure side, Cast iron end (all Squirrels except 806LB & 818 from 2018 to 2020) – **PHTK 6/6/4CH \$558.50 + GST**

Hydraulic Pump Triple *Koreson* 6+4+4cc Group2, 4bolt flange 1/2" BSP & 3/4" UNO ports Cast iron end (Squirrels 806LB & 818 2018 to 2020) – **PHTK6/4/4CH \$558.50 + GST**

Hydraulic Pump Triple *Koreson* 8+6+6cc Group2, 4bolt flange 1/2" BSP & 3/4" UNO ports, Cast iron end (all Squirrels from 2021 except for 818) – **PHTK 8/6/6CH \$571.32 + GST**

Hydraulic Pump Triple *Koreson* 8+6+4cc 4bolt flange, 1/2" BSP suction side & 3/4" UNO ports pressure side, Cast iron end (Squirrels 818B from 2021) – **PHTK 8/6/4CH \$571.32 + GST**

Hydraulic Pumps – (Koreson, 4,400 psi seals) (from 6-2018)



Hydraulic Pump "*Koreson*" 4cc Groop 2, Group2, 4bolt flange, 1/2" BSP suction side & 3/4" UNO ports pressure side, Cast iron end (Old Single speed Squirrels) – **PHSK4CH \$180.68 + GST**

Hydraulic Pump "*Koreson*" 6cc Groop 2 Group2, 4bolt flange, 1/2" BSP suction side & 3/4" UNO ports pressure side, Cast iron end – **PHSK6CH \$180.68 + GST**

Hydraulic Pump "*Koreson*" 8cc, Group 2, Group2, 4bolt flange, 1/2" BSP suction side & 3/4" UNO ports pressure side, Cast iron end – **PHSK8CH \$180.68 + GST**

Hydraulic Pump "*Koreson*" 12cc, Groop 2, 4bolt flange 1/2" BSP suction side, Cast iron end, internal spline on bottom shaft to (replace front 8cc on triple pump) – **PHSK12CH \$200.75 + GST**

Hydraulic Pump Spares – (Koreson)



Seal kit Group2 Koreson & Alfred triple & double pump (from 6-2005) – **PHTKG2SK \$44.36 + GST**



Shaft seal for Group2 *Koreson* & *Alfred* triple & double pump, 2 part 28.58 od x 19.05 id x 8 wide (from 6-2005) – **OS19.05*28.588 \$18.78 + GST df**



Woodruff Key 5/8"x1/8" – **KW5/8x1/8**

Hydraulic Pumps – (ALFORD)

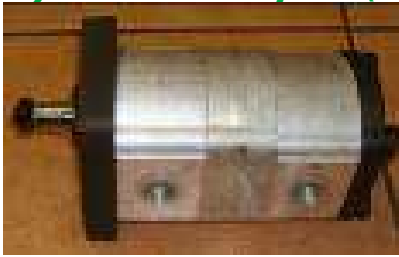

Hydraulic Pump Double *Alfred* 4+4cc Group2 4bolt flange 1/2" BSP Cast iron end (older 2 speed Squirrels) – **PHDAM4/4CICH**

Hydraulic Pump Double *Alfred* 6+4cc Group2 4bolt flange 1/2" BSP Cast iron end (3 speed Squirrels) – **PHDAM6/4CICH**

Hydraulic Pump Double *Alfred* 6+6cc Group2 4bolt flange 1/2" BSP Cast iron end – **PHDAM6/6CICH**
\$523.38 + GST



Hydraulic Pump Triple *Alfred* 6+4cc Group2 & 1.6cc Grp 1 4bolt flange 1/2" BSP Cast iron end – **PHTAM6/4/1.4CH**

Hydraulic Pumps Spares – (ALFORD)



Seal kit 6/4cc Groop2 ALFORD double pump – **PHDAM6/4SK**

Hydraulic Pumps Spares (Salami)

(1985 – 1995)

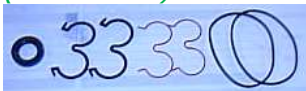

SEAL KIT Groop2 Hyd Pump - **PHSSK2PB**

Hydraulic Pumps Spares (Danfoss)

(1995 – 2005)



Seal kit for Group 2 Danfoss Double pump – **PHDSKG2**

Hydraulic Pumps Spares – (Marzocchi)

(1990 – 1995)



Seal kit Group1 MARZOCCHI Hyd Pump – **PHMG1SK**



MARZOCCHI Hyd Pump internal O-rings for Group 1.5 –
Outer O ring 134N7 - **ORBS134**
Inner O ring 130N7 - **ORBS100**



MARZOCCHI Hyd Pump shaft seal for Group 1.5 24 od x 14 id x 7 high – **OS142407**

Hydraulic Pumps Spares – (Vivoil)

(1990 – 1995)



Seal Kit Grp1 Vivoil Hyd Pump - **PHVSKG1**



Seal Kit Group2 Vivoil Hyd Pump - **PHVSKG2**

Hydraulic Pumps Spares – (Dowty)

(1990 – 1995)

Not available

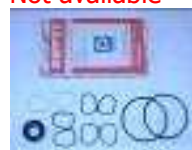

Seal Kit DOWTY Hydraulic pump – **PHDOPSK**

Hydraulic Motors – BMSY Taizhou

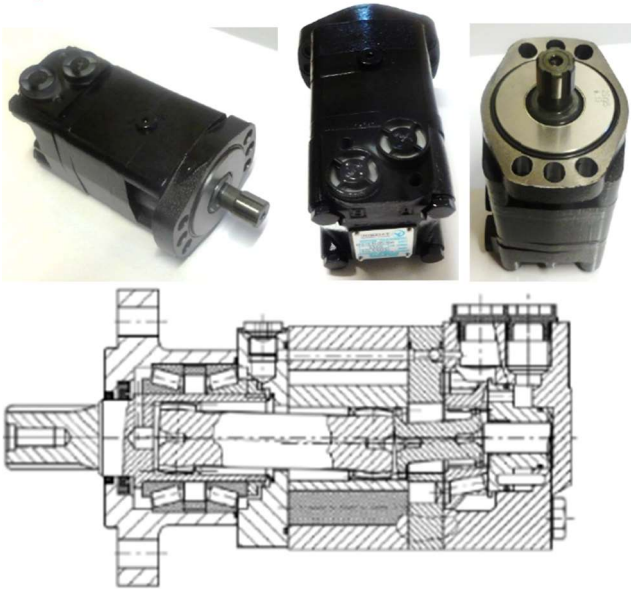

Motors for Planetary wheel drive from 2022
 (This is what we use now has- 3,600 psi (250 bar) shaft seals, 2 heavy tapered bearings, very low internal leakage, (very high performance) (558, 678, 708 & 818)
 With 1" 6B Spline shaft, 7/8" UNO ports, large 6 bolt flange, 3,600 psi 250 bar shaft seal, 1/4" case drain port, over run check valves, disk drive valve plate - for planetary wheel hubs.

Hydraulic motor, for 508 LVI & 558 CS; 160cc – **MHCBMSY160F6S1S** \$579.65 + GST df

Hydraulic motor, for 558, 638 CS, 708 LVI & 708; 200cc – **MHCBMSY200F6S1S** \$608.40 + GST df

Hydraulic motor, for, 678, 678 Bogy, 250cc – **MHCBMSY250F6S1S** \$623.24 + GST df

Hydraulic motor, for 818; 315cc – **MHCBMSY315F6S1S** \$659.87 + GST df

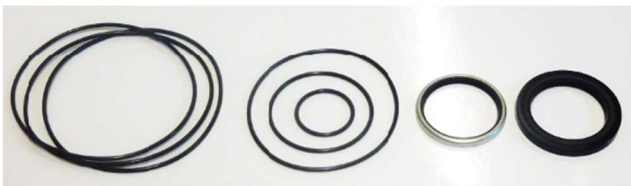

Seal kit for BMSY hydraulic motor (Taizhou Hengchang Hydraulic), high pressure shaft, seal size 48x48x4.7, dust seal. & selection of O-rings– **MHCBMSYSK250** \$73.00 + GST

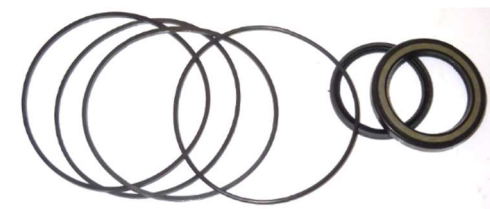

Seal kit for BMSY hydraulic motor (SHIJIAZHANG HANJIU TECHNOLOGY), high pressure shaft seal size 48x48x4.7, dust seal, 1 x O-ring & 3 x square rings– **MHCBMSYSK250SHH** \$73.00 + GST

Hydraulic Motors – TPF BMER-2

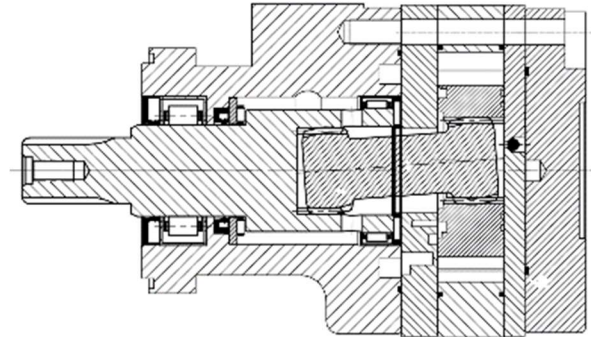

Motors for Planetary wheel drive from late 2018 to 2021 has- 2500 psi (170 bar) shaft seals, 4 shaft bearings, very low internal leakage, high performance) (358, 558, 678 & 818)
 With 1" 6B Spline shaft, 7/8" UNO ports, large 6 bolt flange, 170 bar shaft seal - for planetary wheel hubs

Hydraulic motor, for 508; 160cc – **MHCBMER2-1251S** \$679.74 + GST df

Hydraulic motor, for 558; 160cc – **MHCBMER2-1601S** \$689.86 + GST df

Hydraulic motor, for 678; 200cc - **MHCBMER2-200-1S** \$699.72 + GST df

Hydraulic motor, for 818 2B; 230cc – **MHCBMER2-230-IS** \$716.43 + GST df

**Hydraulic Motors seal kit – TPF
BMER-2**



Seal kit for BMER-2 hydraulic motor, rated to 2,500 psi, 170 bar – **MHCBMER2-SK** \$73.25 + GST



Shaft seal HP BMER-2 hydraulic motor rated to 2,500 psi, 170 bar, 35 id x 48 od x 4.72 wide – **MHCBMER2SS200** \$52.59 + GST

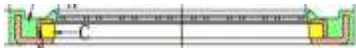

Shaft seal HP BMER-2 hydraulic motor special made rated to 3,000 psi, 210 bar, 35 id x 48 od x 4.72 wide – **MHCBMER2SS300** \$70.02 + GST



Shaft Wiper seal HP BMER-2 hydraulic motor, 57.15 id x 35 od x 6.1 wide – **MHCBMER2DS** \$16.55 + GST

Hydraulic Motors – TPF BMRS

Motors for old Squirrels after 1998 to 2015 (has-3,000 psi (210 bar) shaft seals, Low speed & four shaft bearings)

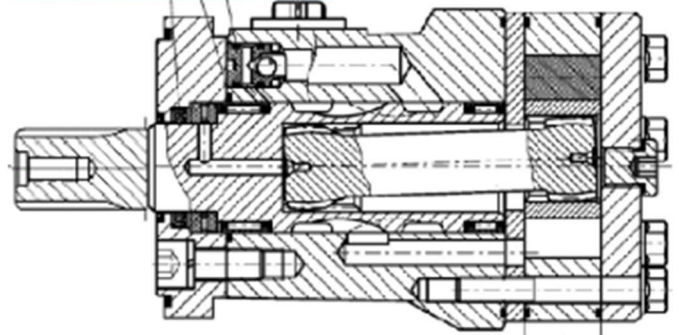

Motors for Planetary wheel drive from 1999 - 2019
(3,000 psi shaft seals, Low speed & four shaft bearings)

With 1" 6B Spline shaft, 7/8" UNO ports, large 4 bolt flange, 3,000 psi, 210 bar shaft seal, over run check valves, - for planetary wheel hubs

Hydraulic motor, for 355; 100cc – **MHCBMRS100SAE6B**
\$464.50 + GST df

Hydraulic motor, for 505; 125cc – **MHCBMRS125SAE6B**
\$486.00 + GST df

Hydraulic motor, for 536; 160cc -- **MHCBMRS160SAE6B**
\$496.00 + GST df

Hydraulic motor, for 656 & 806; 200cc **MHCBMRS2004BF16**
– \$502.46 + GST df

Hydraulic motor, for 657 2B; 250cc – **MHCBMRS2504BF16**
\$511.73 + GST df

Hydraulic motor, 315cc – **MHCBMRS3154BF16**
\$523.08+ GST df

Motors for Chain wheel drive old Squirrels pre-1998

(has- 3,000 psi, 210 bar, shaft seals, Low speed & four shaft bearings)

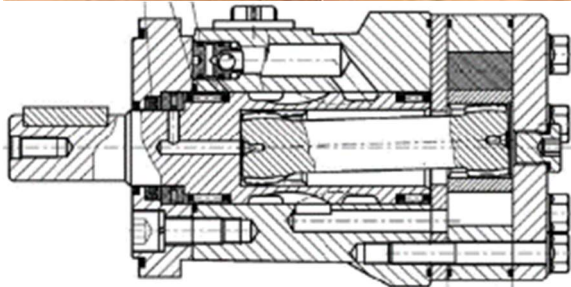

With 1" parallel shaft 1/4" Key – for chain drive

Hydraulic motor, 100cc, 6ci BMRS100 2BF, 1" shaft, 1/4" Key, 7/8 UNO ports, 2 bolt flange, 3,000 psi, 210 bar shaft seal – **MHCBMRS1002B1S** \$464.50 + GST df

Hydraulic motor, 125cc 7.7ci BMRS125 2BF 1" shaft, 1/4" Key, 7/8 UNO ports, 2 bolt flange – **MHCBMRS1252B1S** \$486.00 + GST df

Hydraulic motor, 160cc 9cc BMRS160 2BF 1" shaft, 1/4" Key, 7/8 UNO ports, 2 bolt flange – **MHCBMRS1602B1S** \$496.00 + GST df

Motors for Chain wheel drive very old Squirrels pre-1980



Hydraulic motor, 100cc 6ci BMRS100 4BF 1" shaft, 1/4" Key, 7/8 UNO ports, 2 bolt flange – (very old chain drive pipe frame squirrels) **MHCBMRS1004B1S** \$464.50 + GST df

Hydraulic Motors – TPF BMRS Parts



Shaft seal HP BMRS hydraulic motor 28.56 × 39 x 5.5 – **MHCBMRSH PSS** \$31.76 + GST



Dust seal HP for BMRS hydraulic motor – **MHCBMRS DS**



Shaft bearing kit for BMRS hydraulic motor - **MHCBMRSSB**

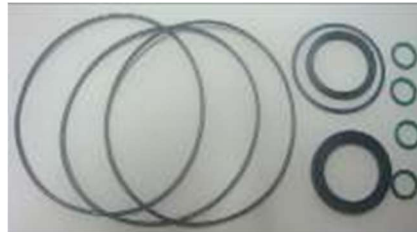

Seal kit for BMRS hydraulic motor, 250bar shaft seal (28.56 × 39 x 5.5) – **MHCBMRSSK250** \$74.13 + GST



Seal for Shuttle Check valve on BMRS-N hydraulic motors grade 90 (4 required per motor) – **ORM10X2**



Woodruff Key 1x 1/4" – **KW1/4X1**



keyway 1/4" x 1/4" x 25mm for hydraulic motor – **KS1/4x1***

Hydraulic Motors - Char-Lynn
H & S series (1965 - 1980)



Front flange 4 bolt early style (101 843) -
MHCF1014B

Front flange 4 bolt late style (H007/008 22000-002) -
MHCFBH-008

Front flange 2 bolt (H007/008 22000-001)
 - **MHCF2BH-00**



Seal kit for S Series 1" straight shaft 60042 (005/006) -
MHCSK60042



Seal kit for S Series 1" stepped shaft 60026 (007)
 - **MHCSK60026**

Seal kit H008 60540-000 suits 22000 4B front flange -
MHCSK60540

Seal kit H007 60023 - **MHCSK60023**



Shaft seal 9057-01 (H/S 007) - **MHCSS9057**

Shaft seal 9057-14 (H008 22000 Flange) -
MHCSS9057-14

Dust seal 9121-2 for H008 22000-2 4 bolt front flange -
MHCD9121-2

Quad ring for 101 4 Bolt flange 843 - **MHCQR20599**



Thrust bearing 7537-000 H Series - **MHCTB103**



Flanged Cap Screw 8mm (16292-088) - **MHCCS**



Woodruff Key 1x 1/4" - **KW1/4X1**

Hydraulic Motors - White
RS series (1975 1995)

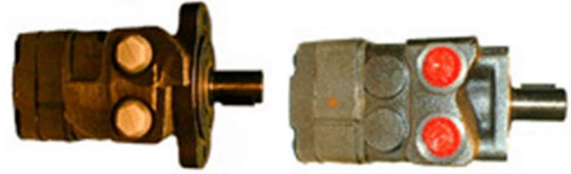

4.6cu RS 2 bolt flange - **MWRS04340100**

4.6cu RS 4 bolt flange - **MWRS04020100**

6.3cu RS 2 bolt flange - **MWRS06340100**

6.8cu RS 4 bolt flange - **MWRS06020100**

10cu RS 2 bolt flange - **MWRS10340100**

10cu RS 4 bolt flange - **MWRS10020100**

17.9cu RS 2 bolt flange - **MWRS18340200**



Seal Kit WHITE RS (Short)- **MWRSSKS**



Seal Kit WHITE RS (Full)- **MWRSSKF**



Thrust Bearing WHITE HS/RS - **MWRSTB**

Hydraulic Motors – Danfoss parts

(1990 - 2005)



Seal kit Danfoss OMP 151-1279 – **MHDOMP80SK**



Seal kit Danfoss OMR 151-1280 – **MHDOMRSK**



Dust seal for OMP/OMR 151-131300 – **MHDOMPDS**



Shaft seal HP for OMP/OMR 633B036100 – **MHDOMPSS**

Hydraulic Motors – Renold parts

(1995 - 2005)



Seal kit GMD100 Motor SKGMD100 – **MHRGMD100**

Hydraulic Motors – Senwei Parts

(2005 - 2006)



Thrust bearing & washer OMRS- **MHCOMRSTBW**



Needle roller bearing OMRS – **MHCOMRSNRB**



Bearing for shaft OMRS – **MHCOMRSSB**

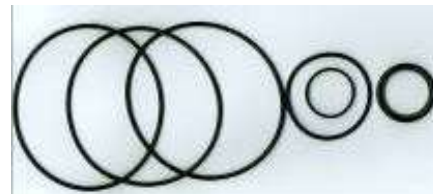

Seal kit for Senwei OMRS hydraulic motor rs – **MHCOMRSSK**

Hydraulic Motors – M&S parts



Seal kit MLHR motors 1¼" shaft – **MHMLHRSK**

Seal kit HP motors – **MHHP SK**

Seal kit HR motors - **MHHR SK**

Hyd pressure test kits



Hyd pressure test point



Hydraulic pressure test point adapter, 3/4" JIC male – female– **TPA3/4JICM-F**

Hyd pressure test Gages



Ø100mm glycerine filled gauge 3,600 psi/250 bar, 1/2" BSPP Part number **GGP100250**



Ø63mm glycerine filled gauge 3,600 psi/250 bar, 1/4" BSPP Part number **GGP3600**

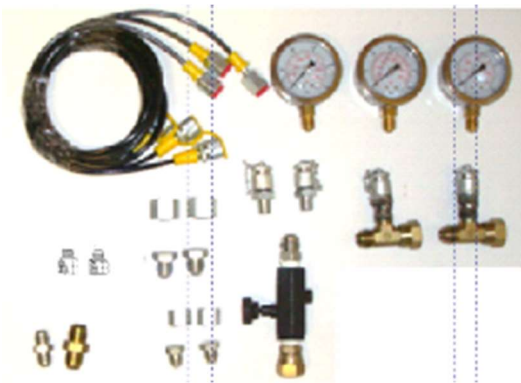

Hydraulic pressure Kit includes

- 3 x 1.5m test tube lines
- 1 x Ø63mm glycerine filled gauge 3,600 psi / 250 bar
- 1 x Ø63mm glycerine filled gauge 5,800 psi / 400 bar
- 1 x Ø63mm glycerine filled gauge 9,000 psi / 600 bar
- 1 x 3/8" check valve / needle valve with 3/4" JIC M-FM
- 1 x 1/8 BSP take-off coupling
- 1 x G1/4 BSP take-off coupling
- 1 x G3/8 BSP take-off coupling
- 1 x 10/1 mm take-off coupling
- 1 x 0/1.25mm take-off coupling
- 1 x 14/1.5mm take-off coupling
- 1 x 7/16-20 UNF take-off coupling
- 1 x 9/16-18 UNF take-off coupling
- 1 x (for Caterpillar CAT) take-off coupling
- 2 x 3/4" tee JIC M-FM pressure take-off coupling
- 2 x 3/4" JIC FM cap
- 2 x 3/4" JIC M plug
- 2 x 9/19" JIC FM cap
- 2 x 9/16" JIC M plug
- 1 x 3/4" JIC M nipple
- 1 x 9/16" JIC M nipple
- 1 x 9/16" JIC male – 3/4" JIC female adapter
- 1 x 9/16" JIC female – 3/4" JIC male adapter

Part number **HPTK*** \$266.00 + GST